



# User Manual

## Asiento

Doc Ref 999-1-57 – en-gb -REV D  
08-03-24

## Contents

1.0	Introduction.....	4
1.1	Manufacture.....	4
1.2	European Authorised Representative.....	4
1.3	Symbols Used.....	5
1.4	Contraindications/Limitations.....	6
1.5	Intended Purpose .....	6
1.5.1	Indications.....	6
1.5.2	Intended User.....	6
1.6	Safety Instructions and Warnings .....	7
2.0	Components/Key Parts .....	9
3.0	Compatible Accessory List.....	10
3.1	Attaching accessories.....	10
3.1.1	4 Point Lap Strap .....	10
3.1.2	Chest Harness .....	11
3.1.3	Hook & Loop and Cocoon Sandals .....	11
4.0	Operating/Adjustment Instructions .....	12
4.1	Manoeuvring the Chair .....	12
4.2	Brakes.....	12
4.3	Pelvic Lap Strap Buckle.....	12
4.4	Adjustments .....	13
4.4.1	Head Rest Position .....	13
4.4.2	Head Rest Pad.....	13
4.4.3	Shoulder Pad Angle.....	13
4.4.4	Back Rest Height/Depth.....	13
4.4.5	Backrest Angle.....	13
4.4.6	Lateral Positioning.....	14
4.4.7	Sacral Pad Positioning.....	14
4.4.8	Seat Height Adjustment & Tilt in Space Operation.....	14
4.4.9	Seat Depth Adjustment.....	14
4.4.10	Hip Guide Adjustment .....	15
4.4.11	Dynamic Back Setting .....	15
4.4.11.1	Adjust Back Rebound .....	15
4.4.11.2	Adjust Back Compression.....	15
4.4.11.3	Dynamic Back Pressure .....	15
4.4.12	Leg Rest Angle .....	16
4.4.13	Leg Rest Height.....	16
4.4.14	Leg Width & Wind Sweeping .....	16
4.4.15	Knee Cushion Swing Away.....	16
4.4.16	Footrest Angle.....	16
4.4.17	Tray Height & Angle .....	16

4.4.18	Tray Removal & Depth.....	17
4.4.19	Armrest Position.....	17
4.4.20	Armrest Height/Angle Indicators.....	17
4.4.21	Armrest Removal.....	17
5.0	Technical Specifications.....	18
5.1	Asiento Chair Dimensions.....	18
5.2	Standards Applied.....	19
6.0	Environmental Conditions.....	20
6.1	Normal operating conditions.....	20
6.2	Shipping and storage conditions.....	20
7.0	Daily Checks.....	21
8.0	Cleaning.....	23
8.1	Metal Frame Cleaning.....	23
8.2	Fabric Cleaning.....	23
8.3	Harness / Strap Cleaning.....	23
8.4	Disinfecting (if necessary).....	23
9.0	Servicing.....	25
9.1	Nominal Service.....	25
9.2	Extending Nominal Service Life.....	25
9.3	User Serviceable Parts.....	26
9.4	Documentation/ Records.....	26
10.0	Troubleshooting.....	26
11.0	Disposal.....	27
12.0	Warranty.....	27
13.0	Service Record History.....	28
13.1.1	Product Information.....	28
13.1.2	Service & inspection record for.....	28

## 1.0 Introduction



This user manual should be kept safe for future reference.



Please read and understand this manual in its entirety before using your Asiento Chair.

The information in this manual is important for the safety of anyone near the chair and must be read and understood to help prevent injuries. It is also crucial to the proper operation and maintenance of the Asiento chair.

Should any questions arise from reviewing this manual, contact your local authorised representative.

Failure to comply with warnings in this manual may result in; injury to the operator and/or client and/or damage to the chair or related components.

If, during the use of this device or because of its use, a serious incident has occurred please report it to the manufacturer and to your national authority.

Store this manual with the documents included with the Asiento chair. Contents of this manual are subject to change without prior written notice.



Do not attempt to use this equipment without first understanding the contents of this manual.



Unauthorised modifications on this product may affect its safety. The manufacturer will not be held responsible for any accident, incident or deficiencies of performance that occur because of any unauthorised modification to its products.

## 1.1 Manufacture

The chair is manufactured at the address below:



Smirthwaite  
16 Wentworth Road Heathfield, Newton Abbot TQ12 6TL  
Telephone number: 01626 835552

## 1.2 European Authorised Representative



The address of the European Authorised Representative for this product:



European Healthcare & Device Solutions (Ireland) Ltd.  
Stratton House, Bishopstown Road,  
Cork, Ireland.  
T12 Y9TC.  
Telephone number: +353(86)2280846.

### 1.3 Symbols Used

The Table below includes all Symbols from BS EN ISO 15223-1:2021 that can be found in this Manual and on the Product and what they represent. Refer to this Table when you are unsure of what a symbol represents.

			
Place of Manufacture	Country of Manufacture	Serial number	Catalogue number
			
Medical Device	CE Marking	European Authorised Representative	Safe Working Load
			
For internal use only	Packaging indicator – Keep dry	Do not use if package is damaged	Packaging indicator – This way up
			
Fragile, handle with care	Please observe local laws on recycling	Non-sterile	Degree of protection provided by enclosure.
			
Temperature range	Humidity range	Atmospheric pressure limitation	Consult instructions for use
			
Caution – see instructions for use	UK Conformity Assessment Marking		

## 1.4 Contraindications/Limitations

Contraindications of the chair include:

- Users with known sensitivity to synthetic rubber should not use the chair.

It is recommended that a client specific assessment is completed by a trained and knowledgeable health care professional to determine the best method of transfer and use.

Smirthwaite Ltd. does not recommend a required number of operators for the use of our products. This information and recommendation can only be provided after a thorough personalised, case specific assessment, as there are many factors that can influence these decisions.

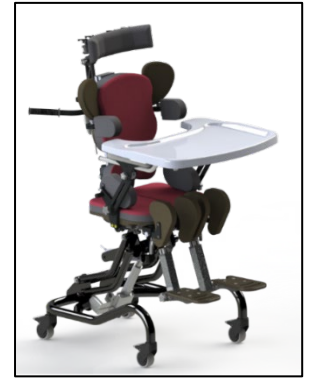

Limitations of the chair include:

- The chair should only be operated by competent and trained persons.
- The chair should only be used with patients weighing under the safe working load of the chair.
- Between the chair and other accessories, the lowest safe working load of the components should not be exceeded.
- The chair is only to be used within the environment it is installed into. The chair must only be relocated by an authorised person.
- The chair is only compatible with the allocated accessories found within this manual.
- The chair is designed for human transfer only. There is no other application to this product.
- The operator of the chair must always pay attention to the well-being of the patient.
- Users should not be left unsupervised during operation.
- The chair is not designed for self-adjustment. A carer must operate the chair during use.

## 1.5 Intended Purpose



For internal use only. The Asiento chair is intended to enable users with moderate to complex postural support needs to develop and maintain healthy posture and promote visual, hearing, communication, fine motor control and social engagement.

### 1.5.1 Indications

The Asiento Postural support chair is indicated for use by children and adults from the age of 1 who have moderate to severe motor dysfunction that limits their ability to maintain postural control.

### 1.5.2 Intended User

The Asiento has been designed specifically for children, teenagers & adults with moderate to complex postural support needs. Caregivers include carers, therapist, and/or teaching staff who will maintain & clean the chair as per the recommended guidelines in section 'Cleaning'. Under their care, they will be responsible for helping the user in & out the seat & their safety when sitting in the Asiento.

The Asiento (size 1 and 2) has a maximum weight limit of 80kg, the Asiento size 3 has a maximum weight limit of 120kg, this load must not be exceeded.

The device is used under instruction, and the operation of the aid is undertaken by a trained carer. A risk assessment must be performed before using the chair to ensure safe use can be established.



You may need to seek specialist advice on how to assist some people with specific moving and handling needs. Sources of advice include, but are not limited to, professional bodies and organisations, occupational therapists, physiotherapists, manual handling advisers and ergonomists with experience in health and social care.

## 1.6 Safety Instructions and Warnings



Ensure to read and understand all the statements below, for the safety of the caregivers and users, along with warranty requirements.

- The user should NOT be left unattended whilst in the chair. Always ensure a responsible therapist or carer is in attendance.
- If you believe the chair or any fitted accessory to be faulty at any time, do not use – contact Smirthwaite Ltd. by telephone on +44 (0)1626 835552.
- The therapist should be familiar with the methods of adjustment and have completed all adjustments appropriately to meet the needs of the user before transferring the user onto the chair.
- The chair is only to be used indoors on a flat level surface.
- When transferring the user to a different location using the chair, it is important to ensure that the chair is set at its lowest height position. Avoid transferring the user at an adjusted height, as this may compromise safety and stability.
- Do not exceed user maximum weight limits.
- Always fasten the pelvic strap and any other straps provided with the chair.
- Always keep this product away from naked flames, cigarettes and sources of heat including open fireplaces, radiators, heaters.
- DO NOT fit parts or accessories of other manufacturers to this product unless authorised to do so in writing by Smirthwaite Ltd. Failure to follow these instructions will not only invalidate the guarantee but could make the chair dangerous to use.
- Smirthwaite Ltd will not accept liability for any injury or damage incurred through such malpractices. Any repairs required must be carried out by Smirthwaite Ltd authorised personnel.
- Lap straps and harnesses must be appropriate and safe for the user and the users clothing. Lap straps and harnesses must be checked every time the chair is used to ensure they are fitted as prescribed by the clinician, take account of the users clothing, and are tightened so that the user cannot sustain injury. Checking the fit of lap straps and harnesses must be done with the user in the chair and should be undertaken as soon as the users sits in the chair.
- A risk assessment must be performed before using any manufactured chair, to ensure safe use can be established.
- The chair is intended to be installed on a flat and levelled surface prior to use.
- All chairs are less stable on sloping surfaces. A 5-degree slope is the maximum permitted.
- Take care during the transfer of the person; do not move the person at speed, as this increases the risk of an accident.
- All chairs are less stable when the load is moving.
- The chair must be installed only by persons authorized by Smirthwaite or who have the rights to install and commission the chair safe for use.

- Under no circumstance should the chair be put in control of a person who has not been properly trained in the use and care of this equipment. Failure to adhere to this warning may result in serious injury to the operator and/or the individual being transferred.
- The chair, and its accessories (including harnesses) are not toys. Do not use it for unsafe practices. Do not allow children to play with the chair or any of its components. The chair should not be used for any practice except its intended use.
- In facilities where more than one operator will be responsible for using the chair, it is imperative that all such members be trained on the chair prior to use. A training program should be established by the facility to acquaint new operators with this equipment.
- To maintain optimum function, the chair should be inspected and maintained on a regular basis. See section 'Daily checks, Servicing and Cleaning' within this user manual.
- The chair and its accessories are intended only for seating of a person. Smirthwaite will not be responsible for any damage caused by the misuse, neglect, or purposeful destruction of the unit, and/or its associated components.
- In areas where children are likely to be present, be vigilant during use.
- Any accessories used with the chair including the harness, should be checked to ensure that they are in good working order. Check for signs of wear to each component prior to use. Report any unusual wear to your local authorized dealer.
- The chair and its associated parts are certified to a maximum load of 80kg (size 1 & 2)/120kg (size 3). Do not exceed the maximum rated load of any of the components.
- Ensure that a clear space is maintained around the chair. Before use, check for and move all obstacles out of the way.
- Protecting the people present, visually monitor the harness (if applicable) to ensure the user is safe, always be vigilant of the user when there is no harness supporting them.
- To reduce the risk of unintended use, when the chair is not in use remove the harness from the product to prevent entrapment or strangulation should the device be tampered with.
- Between chair and any accessory used with it, the lowest maximum load shall always be used.



## 2.0 Components/Key Parts

When delivered, the chair will be supplied fully assembled except for the attachment of any special accessories ordered. Please see below to familiarise yourself with the components of the Asiento chair. If you have not received all the components listed below, contact your local Smirthwaite dealer immediately – contact details are provided on the last page of this manual.



Item	Description
1	Base
2	Seat
3	Backrest
4	Lumbar Support
5	Multi-Adjust Headrest
6	Armrests
7	Shoulder Protractors
8	Swing Away Laterals
9	Quick Release Tray
10	Hip Guides
11	Abductor Pad
12	Adductor Pad
13	Multi-Positional Leg Rest

Table 2-1

Fig. 2-1

### 3.0 Compatible Accessory List

The Asiento chair comes with a variety of compatible accessories. These accessories and part codes are listed below.

Table 3-1

Approved Accessories	Size 1	Size 2	Size 3
Chest Harness	ST088-Small/ST089-Medium	ST089-Medium/ST090 - Large	ST090- Large/ST091 X-Large
Four-point lap strap size 1	HN077	HN077	HN077
Four-point lap strap size 2	HN078	HN078	HN078
Hook and Loop sandal size 1	SL001	SL001	SL001
Hook and Loop sandal size 2	SL002	SL002	SL002
Hook and Loop sandal size 3	SL003	SL003	SL003
Hook and Loop sandal size 4	SL004	SL004	SL004
cocoon sandal – std width – Hook and Loop size 0	SL005	SL005	SL005
cocoon sandal – std width – Hook and Loop size 1	SL007	SL007	SL007
cocoon sandal – std width – Hook and Loop size 2	SL009	SL009	SL009
cocoon sandal – std width – Hook and Loop size 3	SL011	SL011	SL011
cocoon sandal - std width – Hook and Loop size 4	SL013	SL013	SL013

### 3.1 Attaching accessories

The sections below will give detailed instructions on how to install and remove the accessories from your chair. These instructions must be adhered to for a successful and safe assembly of the chair. If you are unsure of any processes, always seek advice.

#### 3.1.1 4 Point Lap Strap

The 4 Point Lap Strap are installed and removed following the same process. Follow the instructions below to install and remove the Harness.

To fit the harness, following these steps:

- Feed the 4 straps through cam locks (1,2,3 & 4).

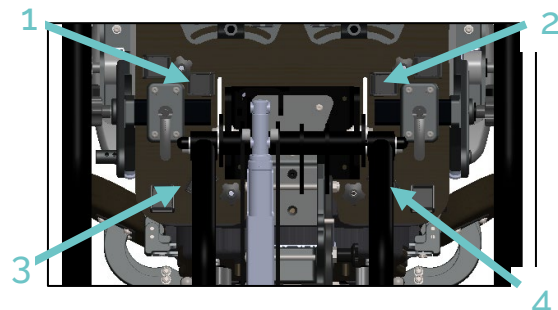
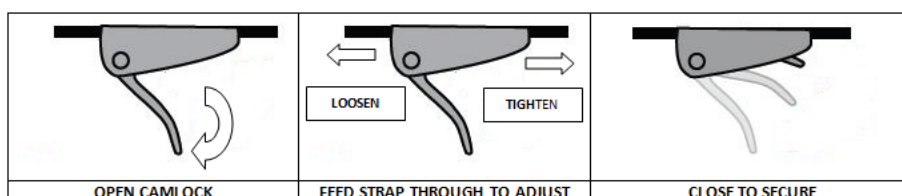

Fig. 3-1-1-1



### 3.1.2 Chest Harness

The Chest Harness are installed and removed following the same process. Follow the instructions below to install and remove the Harness.

To fit the harness, following these steps:

- Feed the 4 straps through cam locks (1,2,3 & 4 below).

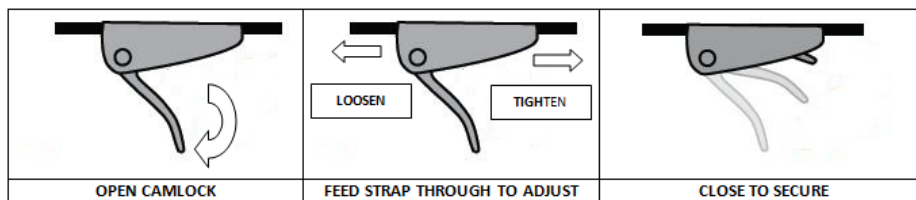
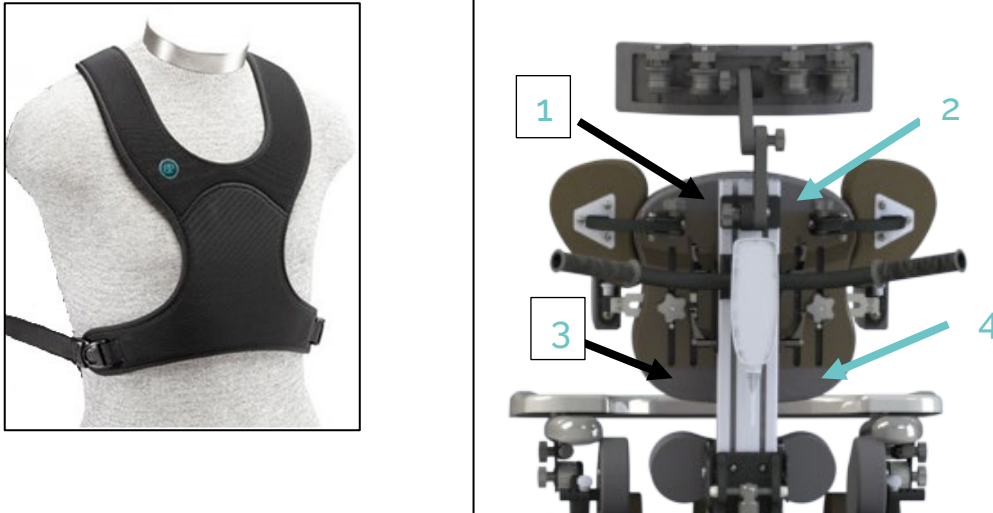

Fig. 3-1-2-1

### 3.1.3 Hook & Loop and Cocoon Sandals

Both types of sandals are fitted to the footplates using the following guidelines.

- Place the sandal onto the footplate, aligning the fasteners with the front and back slots on the footplate as shown in Fig. 3-1-3-1.
- Insert the T-nut in the designated slot on the underside of the footplate, as shown in the Fig. 3-1-3-2.
- Thread the screws through the slot in the sandal, making sure they engage with the T-nut as shown in Fig. 3-1-3-3.
- To secure the sandal into position, use a 4mm Allen key to tighten the screws.

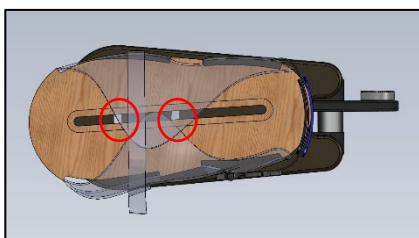

Fig. 3-1-3-1

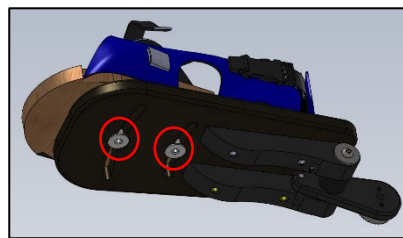

Fig. 3-1-3-2

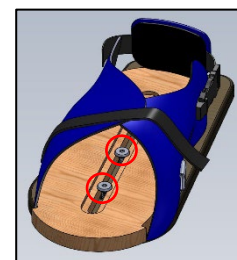

Fig. 3-1-3-3

## 4.0 Operating/Adjustment Instructions



Appropriate training in postural seating procedures should be undergone by any person operating the chair, for their own and the client's safety and comfort. These instructions are designed to cover the methods of using the Asiento.

### 4.1 Manoeuvring the Chair

The Asiento is designed with castors, allowing transfer and manoeuvrability of the chair, to manoeuvre correctly, follow the guidance below.



When transferring the user to a different location using the chair, it is important to ensure that the chair is set at its lowest height position. Avoid transferring the user at an adjusted height, as this may compromise safety and stability.

- A. To manoeuvre the chair, hold onto the handles and push forward, the designated handle is located behind the backrest and can be held at the comfiest location. Always use two hands to manoeuvre the chair.
- B. To manoeuvre the chair in the forward direction of travel, the handle must be used.
- C. To rotate the chair, ensure both hands are used on the handle to control the product. Alternatively, it is possible to rotate the chair by applying a single brake, which will allow the user to rotate the chair around the castor. This manoeuvring must be done with a smooth, slow action to avoid discomfort to the patient. See section 4.2 on how to activate the brakes.

### 4.2 Brakes

- A. The Smirthwaite Asiento chair has four braked castors.
- B. The castors should/can be applied when parking, to avoiding lateral movement, and using the chair and as an emergency stopping system.
- C. To apply the brake, simply press the lower end of the brake pedal down with your foot.
- D. To release the brake, simply press the top end of the brake pedal down with your foot.

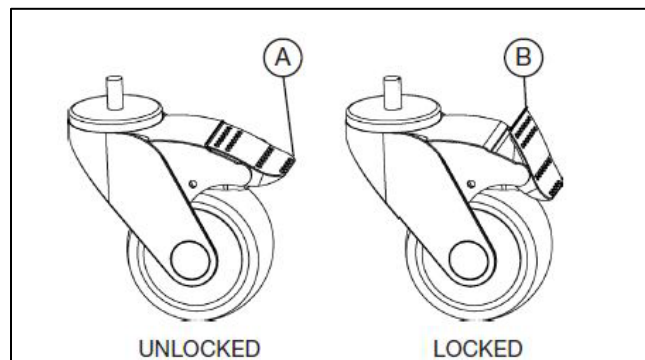

Fig. 4-2-1

### 4.3 Pelvic Lap Strap Buckle

Below is a step-by-step instruction guide on how to operate the pelvic lap strap buckle.

- A. Press areas (U) to unlock the buckle and pull the two buckle parts apart.
- B. To fasten simply reconnect the two parts – the buckle will 'click' and lock.



Fig. 4-3-1

## 4.4 Adjustments

The Asiento has components that are adjustable to your requirements. See the instructions below on how to adjust these components correctly. If you are unsure of any process, do not continue and seek advice.

### 4.4.1 Head Rest Position

To adjust the head rest position, release the desired hand wheels, as shown in Fig. 4-4-1-1 (highlighted in yellow).

Once released, you can adjust the head rest to achieve the desired position. Once in place, tighten the hand wheels to secure the head rest.



Fig. 4-4-1-1

### 4.4.2 Head Rest Pad

To individually adjust the angle of each head rest pad simply release the hand wheels on the top of the headrest, as shown in Fig. 4-4-2-1 (highlighted in yellow).



Fig. 4-4-2-1

### 4.4.3 Shoulder Pad Angle

To adjust the shoulder pad angle, release the lever locks on the top of the chair, as shown in Fig. 4-4-3-1 (highlighted in yellow).

Once released you can change the angle to the desired position. Repeat this operation to adjust the other side.

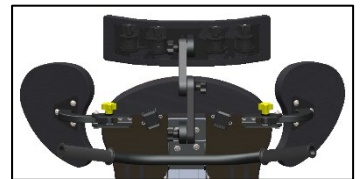

Fig. 4-4-3-1

### 4.4.4 Back Rest Height/Depth

To adjust the back rest height, move the lever lock into place (located on the back of the chair as shown in Fig 4-4-4-1 highlighted in yellow).

Once released, you can move the backrest up and down, and adjust the angle and depth of the back rest too.

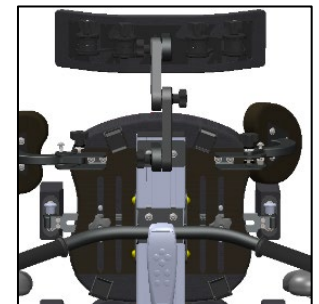

Fig. 4-4-4-1

### 4.4.5 Backrest Angle

To adjust the back rest angle, release the plunger pin on the back of the chair as shown in Fig. 4-4-5-1 (highlighted in yellow).

Once released, you can change the back rest angle to the desired position in 7-degree increments.

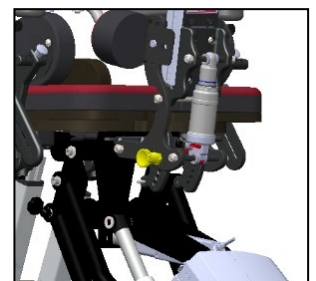

Fig. 4-4-5-1

#### 4.4.6 Lateral Positioning

To adjust the laterals in height and width, locate the hand wheels on the back of the chair and release. Once released you can move the laterals to the position desired, as shown in see Fig. 4-4-6-1 (highlighted in yellow).

To release the lateral swing away mechanism, release the plunger pin located on the top of the lateral by pulling up, this will allow them to swing away, as shown in Fig. 4-4-6-2 (highlighted in yellow)

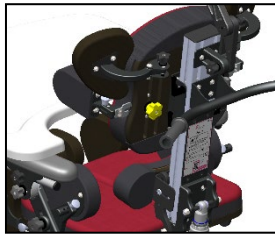

Fig. 4-4-6-1

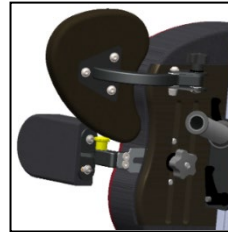

Fig. 4-4-6-2

#### 4.4.7 Sacral Pad Positioning

Adjusting the sacral pad position will require the use of a 4mm hex key.

To adjust the sacral pad, release the two bolts behind the pad, they are positioned either side of the mount, see Fig. 4-4-7-1 (highlighted in yellow).

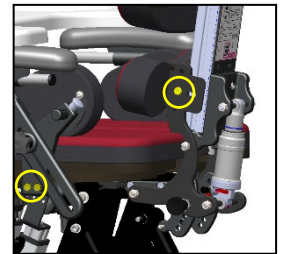

Fig. 4-4-7-1

#### 4.4.8 Seat Height Adjustment & Tilt in Space Operation

To adjust the seat height, locate the handset, which is located on the back of the chair, as shown in Fig. 4-4-8-1 (highlighted in yellow). Once located use the up and down buttons to position the seat to the desired height. CAUTION - Ensure the footrest is raised when lowering the chair.

To tilt the chair backward and forward, use the tilt in space buttons located on the handset.

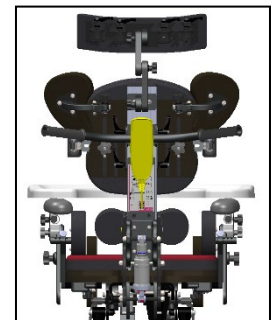

Fig. 4-4-8-1

#### 4.4.9 Seat Depth Adjustment

To adjust the seat depth, locate the hand wheels located underneath the seat, as shown in Fig. 4-4-9-1 (highlighted in yellow). Once located release the hand wheels and move the seat forward or back to the desired position. CAUTION - Ensure the footrest is raised when lowering the chair.



Fig. 4-4-9-1



#### 4.4.10 Hip Guide Adjustment

To adjust the hip guides locate them on either side of the seat base, release the plunger pin, as shown in Fig. 4-4-10-1 (highlighted in yellow).

Position the hip guides and release the pins to lock in place.



Fig. 4-4-10-1

#### 4.4.11 Dynamic Back Setting

The asiento back features dynamic setting located on the shock absorber at the rear of the chair, as shown in Fig 4-4-11-1. To adjust these setting, please follow the guidance provided below.

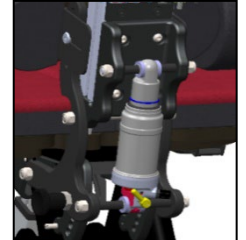

Fig. 4-4-11-1

##### 4.4.11.1 Adjust Back Rebound

To adjust the rebound of the chair's back, locate the wheel (highlighted in yellow) on the shock absorber at the rear of the chair, as shown in Figure 4-4-11-1-1. To increase damper (slow) the rebound, turn the wheel in the direction marked "+" and to decrease damper (fast), turn the wheel in the opposite direction marked "-", as also shown in the same figure.

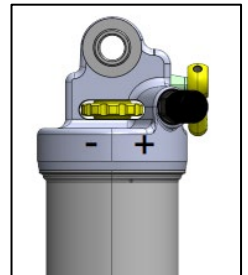

Fig. 4-4-11-1-1

##### 4.4.11.2 Adjust Back Compression

To adjust the compression of the chair's back, locate the lever (highlighted in yellow) on the shock absorber at the rear of the chair, as shown in Figure 4-4-11-2-1. To increase open-up the compression, rotate the lever in the direction marked "-" and to firm lock-out the compression, rotate the lever in the direction marked "+" as shown in the same figure.

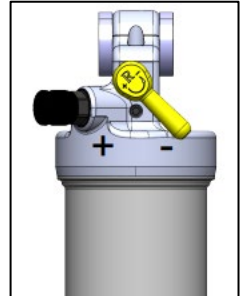

Fig. 4-4-11-2-1

##### 4.4.11.3 Dynamic Back Pressure

To alter the pressure in the dynamic back system, locate and remove the valve cap on the shock absorber, as shown in Fig. 4-4-11-3-1 (highlighted in yellow). Attach the hose end of the pump, as shown 4-4-11-3-2 (highlighted in yellow) and secure it to the exposed valve.

Use the pump to increase the pressure in the system. To decrease the pressure, press the red button on the pump, as shown inf Fig. 4.4.11-3.1 (highlighted in red).

Once desired pressure is achieved, remove the pump, and reattach the valve cap.

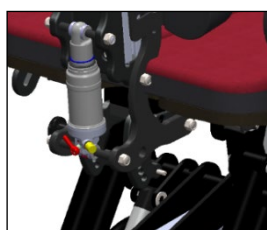

Fig. 4-4-13-1

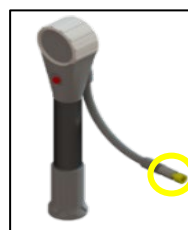

Fig. 4-4-11-3-2

#### 4.4.12 Leg Rest Angle

To adjust the leg rest angle, move the handwheel into place, as shown in Fig.4-4-12-1 (highlighted in yellow), which shows the chair from front to back. Release the handwheels and move the leg rest to the desired angle. Once in place tighten the handwheels.

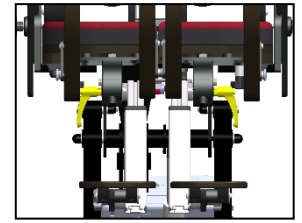

Fig. 4-4-12-1

#### 4.4.13 Leg Rest Height

To adjust the leg rest heights, move the lever lock into place, as shown in Fig. 4-4-13-1 (highlighted in yellow). Pull the pin and move the leg rest to the desired position, once in the desired location ensure the pin locks back into a location hole.

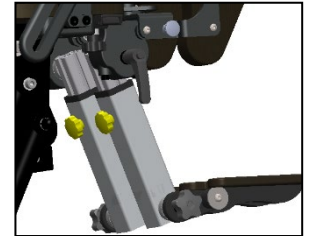

Fig. 4-4-13-1

#### 4.4.14 Leg Width & Wind Sweeping

To adjust the leg rests width and position for wind sweeping release the four screws at the front of the chair, located underneath, as shown in Fig. 4-4-14-1 (highlighted in yellow). Move the leg rest and knee pads to the desired position and tighten the screws.

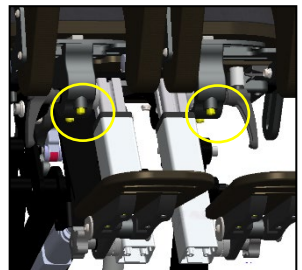

Fig. 4-4-14-1

#### 4.4.15 Knee Cushion Swing Away

To swing away the knee cushions, locate the plunger pin on the side of the relevant knee cushion as shown in Fig. 4-4-15-1. Pull the plunger pin and rotate the knee cushion underneath the seat base.

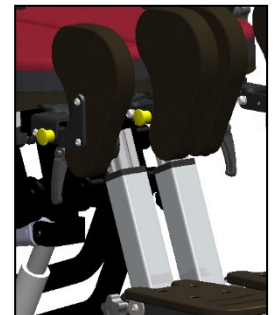

Fig. 4-4-15-1

#### 4.4.16 Footrest Angle

To adjust the footrest angle, locate the hand wheels shown in Fig. 4-4-16-1 (highlighted in yellow). Loosen the hand wheels far enough so that the footrests rotate. Move to the desired position and tighten the hand wheels to set in place. The footrest can be easily flipped up, without loosening the hand wheels.

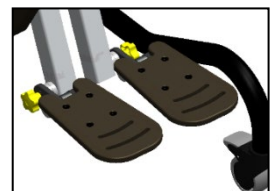

Fig. 4-4-16-1

#### 4.4.17 Tray Height & Angle

To adjust the tray height and angle, locate the bolts on both sides of the chair as shown in Fig. 4-4-17-1 (highlighted in yellow). Move the handwheel into place. To change the tray angle without changing the height, release the top bolt only. Once in the desired position secure by re-tightening the bolts.

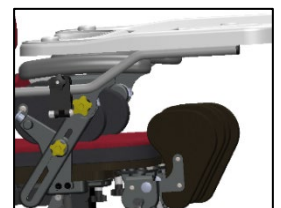

Fig. 4-4-17-1



#### 4.4.18 Tray Removal & Depth

To change the tray depth, locate the small hand wheels on top of the tray assembly, see Fig. 4-4-18-1 (highlighted in yellow). Once located, release and push or pull the tray to the desired depth. Once in position, lock the tray in place by tightening the hand wheels. To remove the tray, simply repeat the first instructions and pull the tray all the way out of the location clamps.

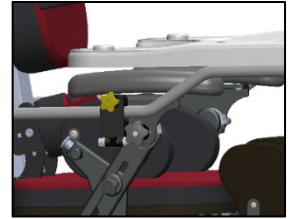

Fig. 4-4-18-1

#### 4.4.19 Armrest Position

To adjust the height and angle of the armrest, locate the two hand wheels on the outside of the chair, see Fig. 4-4-19-1 (highlighted in yellow). Once located, release the hand wheels far enough so that the armrest slides up and down and moves in angle. Once the desired position is achieved lock off the hand wheels.

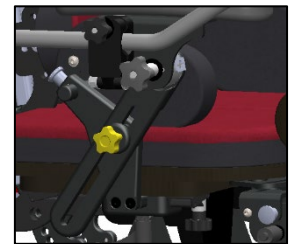

Fig. 4-4-19-1

#### 4.4.20 Armrest Height/Angle Indicators

To align the angle indicators, use the angle indicators located behind the handwheels (see Fig. 4-4-20-1) and the curved notches on the armrest bar (see Fig. 4-4-20-2) to record the desired position of the armrest. All adjustment for height and angle come from the same operation/same two handwheels).

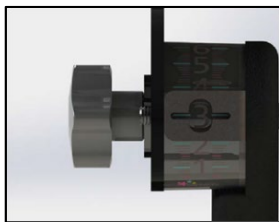

Fig. 4-4-20-1

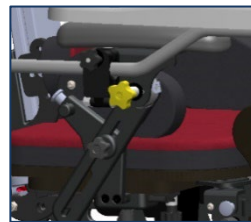

Fig. 4-4-20-2

#### 4.4.21 Armrest Removal

To remove the armrests, locate the hand lever underneath the chair, see Fig. 4-4-21-1 (highlighted in yellow). Once located, release the hand lever, and pull the arm rest out of the clamp.



Fig. 4-4-21-1

## 5.0 Technical Specifications

### 5.1 Asiento Chair Dimensions

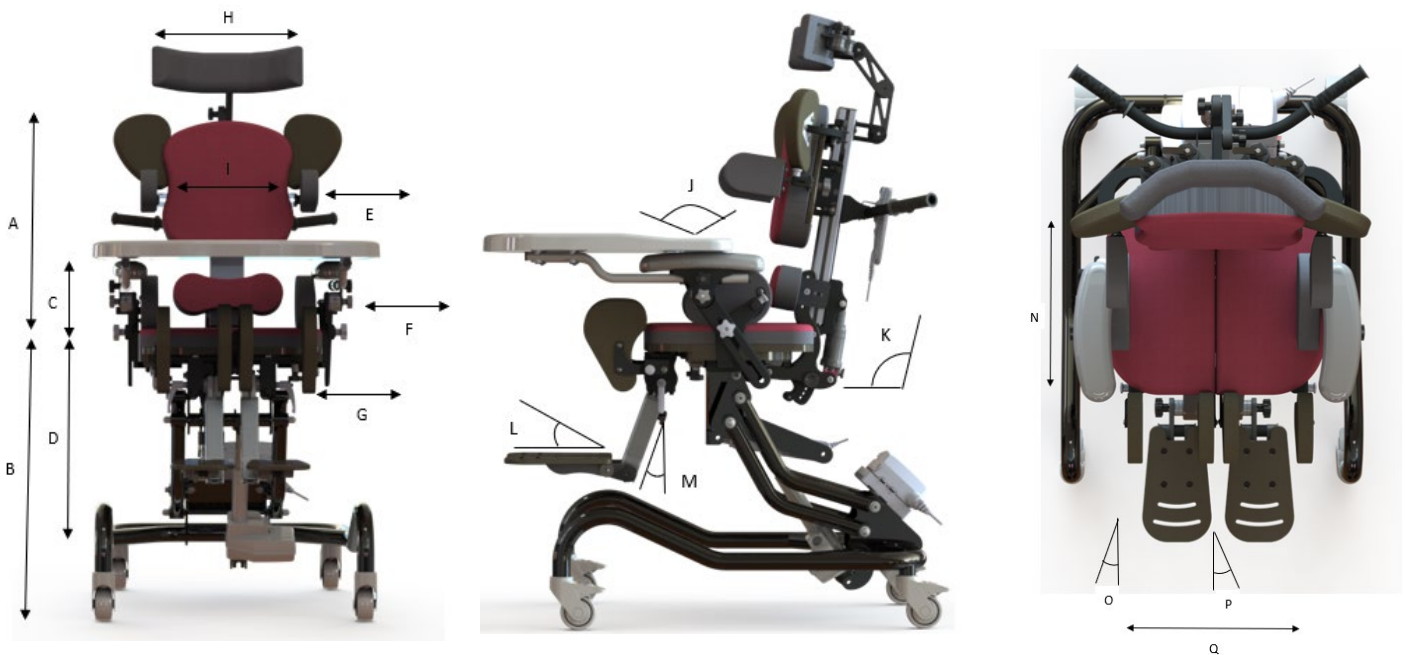

The diagram(s) above include the relevant dimensions of the chair, for further details on the chair specification, see the table below. All dimensions are in millimetres unless otherwise stated.

Table – 5-1-1

		Size 1	Size 2	Size 3
	Age range	1-6 Years	6-12 Years	12-18+ Years
A	Back Rest Height	350 – 430	420 – 510	490 - 590
B	Seat Height From floor	290 – 565	290 – 565	490 - 740
C	Armrest height ( <i>min-max from seat</i> )	110 – 325	110 – 325	110 - 325
D	Lower Leg Length ( <i>Seat to Footplate</i> )	210 – 320	210 – 320	310 - 560
E	Lateral Supports Travel Adjustment	50	65	65
F	Hip Guide Travel Adjustment	70	70	70
G	Abduction Pad Travel Adjustment	50	50	50
H	Adduction Pad Travel Adjustment	50	50	50
I	Chest Width	250 – 350	250 – 390	310-440
J	Armrest angle ( <i>Forwards/Backwards</i> )	90° / 90°	90° / 90°	90° / 90°
K	Back Angle ( <i>Forwards / Backwards</i> )	10° / 32°	10° / 32°	10° / 32°
L	Footrest Angle ( <i>Forwards/Backwards</i> )	90° / 20°	90° / 20°	90° / 20°
M	Footplate Angle ( <i>Plantarflexion/Dorsiflexion</i> )	45° / 25°	45° / 25°	45° / 25°
N	Seat depth	190-335	300-450	400-550
O	Abduction Angle	23°	23°	23°
P	Adduction Angle	23°	23°	23°
Q	Seat Width	285	410	480
R	Tilt in Space ( <i>Forwards / Backwards</i> )	10° / 20°	10° / 20°	10° / 25°
S	Tray size	660 x 440	660 x 440	660 x 440
T	Seat Width Between Thighs	230 - 370	260 - 390	332 - 445

Dimensions	Size 1	Size 2	Size 3
Turning Circle	875mm	875mm	870mm
Overall oHeight	1170mm	1440mm	1600mm
Overall Width	550mm	550mm	615mm
Overall Width (with Quick Release Tray)	565mm	565mm	565mm
Ground Clearance	115mm	115mm	115mm
Front and Rear Castors Size	75mm	75mm	75mm

Weights	Size 1	Size 2	Size 3
Safe Working Load (SWL)	80 kg	80 kg	120kg
Full Product	55.2 kg	57.2 kg	56.5kg

## 5.2 Standards Applied

The standards that have been applied to the device are as follows:

- BS EN ISO 21856:2022 – Assistive Products – General requirements and test methods
- IEC 60601-1-1:2012 – Basic Safety and Essential Performance
- IEC 60601-1-2:2014 – Electromagnetic Disturbances
- IEC 60601-1-1:2010 – Home Healthcare
- IEC 62366-11:2015 – Usability Engineering
- ISO 10993-1:2020 – Biological Evaluation of Medical Devices
- EN ISO 15223-1:2021 – Medical Device Symbols
- BS ISO 20417:2021 – Information Supplied by the manufacture.

## **6.0 Environmental Conditions**

The chair is intended to be used in dry environments. The chair is intended to be used in internal dry environments.

The chair is intended to be used within a professional healthcare facility or home healthcare environment. The chair is not suitable for any other environment.

The chair is not intended to be used in environments where there are rapid changes in the environmental temperature and humidity.

The operation of the chair is not adversely affected by lint, dust or light.

### **6.1 Normal operating conditions**

+5°C to +40°C (41°F to 104°F) at a relative humidity between 15% to 90% RH, non-condensing but not requiring a water vapour pressure greater than 50hPa and atmospheric pressure between 700hPa to 1060hPa.

### **6.2 Shipping and storage conditions**

-25°C to +5°C (-13°F to 41°F) with any humidity level

+5°C to +35°C (41°F to 95°F) at a relative humidity up to 90%,

+35°C to 70°C non-condensing at a water vapour pressure up to 50hPa

During all transportation it is recommended that the chair remains in its original packaging.

It is recommended that the chair is stored in a cool, dry place out of direct sunlight. If cleaning is required after storage, please see section on 'Cleaning' of the user manual for instructions.

Shipping and storage conditions are also contained on Asiento Box Label:

## 7.0 Daily Checks



Inspection is to be completed prior to each use by the user of the Asiento chair.

Should any of the components in the table below fail the inspection, DO NOT use the chair.

Contact your local authorized dealer for service – contact details are on the last page of this manual.

Ensure all component inspections in the Table below are completed prior to each use of the chair.

### Check List before Use

Table 7-1

Component	Service/Inspection required.
Generic	<p>Visual inspection of the external of the chair. Significant damage that may affect the function of the chair along with a clear safety hazard is unacceptable. Check the labelling on the chair to ensure they are all still legible, this includes the Serial Number and other important markings. If labels are not legible, then contact your local authorised dealer immediately.</p> <p>Check all main nuts and bolts to see if they are loose, if they are not tight or you have concerns, then contact your local authorised dealer immediately.</p> <p>The product is not waterproof and is not intended to be exposed to water for elongated periods of time. Always ensure that the product is kept dry.</p>
Castors and Wheels	<p>Examine the products wheels and castors for signs of damage or wear, ensure they run freely and are not cracked.</p> <p>Check to see all castors are flat on the floor and chair is stable.</p> <p>Ensure the product can rotate freely with ease.</p>
Brakes	<p>Ensure the brakes function when activated.</p> <p>Ensure the chair can move freely when the brakes are deactivated. (Ensure they aren't rubbing on the wheels).</p>
Legs	<p>Ensure that the four legs are always in contact with the floor. Uneven legs are a safety hazard.</p> <p>Ensure that the product is used on a level surface.</p> <p>Examine the legs for any cracks or fractures which are a potential safety risk.</p> <p>Ensure that the legs are not bend or out of position.</p>
Frame	<p>Examine the full frame of the product for any cracks or fractures.</p> <p>Ensure the frame is solid and there are no loose attachments between the frame and the accessories or any other constructional part.</p>
Footrest	<p>Inspect the footrests for damage including cuts and breaks.</p> <p>Ensure that the footboard is fixed in position and does not slide back and forth, if this does occur, tighten the star handles on the underside of the footboard.</p> <p>Ensure that all the nuts and bolts that secure the footrest are secure.</p> <p>Inspect the footrest for any deformation due to fatigue. A badly deformed footboard must be replaced.</p>

<p>Seat Pad</p>	<p>Inspect the seat pad for damage including cuts and breaks. Ensure that all the nuts and bolts that secure the seat pad are secure. Inspect the seat pad for any deformation due to fatigue. A badly deformed seat pad must be replaced.</p>
<p>Arm Rests</p>	<p>Inspect the arm rests for damage including cuts and breaks. Ensure that the arm rests are in a fixed in position and aren't loose. Tighten the star handles to avoid unwanted movement. Ensure that all the nuts and bolts that secure the arm rests are secure. Inspect the arm rests for any deformation due to fatigue. A badly deformed arm rest must be replaced.</p>
<p>Back Rest</p>	<p>Inspect the back rest for damage including cuts and breaks. Ensure that the back rest is not sloped, the fixings on either side of the frame must be level prior to use. A sloped back rest is the result of an incorrect adjustment. Ensure that the back rest is in a fixed in position and isn't loose. The back rest should be locked in place into one of the angle configurations. Inspect the back rest for any deformation due to fatigue. A badly deformed back rest must be replaced.</p>
<p>Accessories</p>	<p>Ensure that all accessories used are in good condition. Ensure that there is no cuts and breaks, cracks or fractures to the accessory, any damage that may affect its function or safety. Ensure that all accessories are fixed onto the product correctly, ensure to follow the assembly instructions when assembling yourself. Ensure all fixings are secured and will not come undone during use of the product. Ensure that the accessory used is compatible with your product. Any harnesses used, ensure that they are not worn, no fraying is present and that the locking clips are functional.</p>

## 8.0 Cleaning

To reduce the risk of cross-contamination it is recommended to clean the chair and accessories before use by a different person.



Please follow the recommended cleaning guidelines below on cleaning and disinfecting the chair.

### 8.1 Metal Frame Cleaning

For mild cleaning the frames can be cleaned using a damp cloth, soap and water, or an antibacterial spray. For a deeper clean, a low-pressure steam cleaner can also be used. Do not use a steam cleaner at high pressure, as this could damage the powder coating and labels. Avoid the use industrial bleaches, abrasive cleaners, or organic solvents and refrain from immersing the chair in water. For more stubborn marks on the metalwork gently clean them with a soft brush.

All cleaning solutions must be thoroughly rinsed off the product at the end of the cleaning process and the product dried using a dry cloth/towel. Always ensure the product is dry before use.

### 8.2 Fabric Cleaning

All materials can be wiped down using a damp cloth to remove any mild dirt, dust, and minor spillages. When a spillage occurs, it is recommended that it be cleaned as quickly as possible to avoid any staining; it is good practice to dab the spillage and not to rub it as this could cause staining. For more persistent stains and dirt, hot water with an antibacterial spray can also be used.

All cleaning solutions must be thoroughly rinsed off the product at the end of the cleaning process and dried using a dry cloth/towel. Always ensure the product is dry before use.

### 8.3 Harness / Strap Cleaning

If the harness become heavily soiled, it can be machine washed at a low temperature with a mild detergent but ensure it is drip-dried for optimal care.

### 8.4 Disinfecting (if necessary)

Should the chair require a more thorough cleaning, the use of the Actichlor™ disinfectant product (which is widely available in tablet form and used throughout the healthcare industry) is recommended.



Follow the manufacturer's safety instructions for the use of this cleaning product before use to ensure safe use for the operator and the user.

Ensure the cloth is damp before the cleaning process.

Application is through a clean damp cloth applied to wipe the product down. Use in the following dilutions to ensure an effective clean:

- Actichlor™ dissolvable chlorine tablets provide a concentration of 1000 ppm of available chlorine (0.1%) per 1 tablet.
- 1 tablet (1.7g formed tablet (x1)) will create a virucidal solution, diluted in 1 litre of water to provide effective means to clean a "dirty" product. This is also ideal for use after an outbreak of the Norovirus/winter vomiting and can be used as a precaution against C.Diff. It is effective against viruses, bacteria, spores, yeasts, and moulds.
- A minimum of 5 minutes contact time with the outer components is recommended to prevent virucidal infections, whilst maintaining the integrity of the product. The product can withstand a longer contact period, however a minimum of 5 minutes is required to provide an effective cleaning regime.
- Blood spills should be dealt with by an increased concentration of the solution – please refer to the instructions on the manufacturer's product labelling.

Table 8-4-1

Dilution chart					
Product used as	Product condition	Concentration (ppm)	Dilution qty* (l)	Tablets per 1l (0.26gal)	Contact time (minutes)
Bactericidal	Clean	200	5 (1.32gal)	1	1
	Dirty	1000	1 (0.26gal)	1	5
Yeasticidal	Clean	200	5 (1.32gal)	1	1
	Dirty	1000	1 (0.26gal)	1	5
Fungicidal	Clean	2000	1 (0.26gal)	2	15
	Dirty	5000	1 (0.26gal)	5	15
Mycrobactericidal	Clean	1000	1 (0.26gal)	1	15
	Dirty	5000	1 (0.26gal)	5	15
Virucidal	Clean	500	2 (0.53gal)	1	5
	Dirty	1000	1 (0.26gal)	1	5
Sporcidal (C. Diff)	Clean	1000	1 (0.26gal)	1	10
	-	-	-	-	-
Sporcidal	Clean	5000	1 (0.26gal)	5	10
	-	-	-	-	-

- Dilution is made with water. DO NOT dilute within any other medium.
- When diluted in water, one tablet gives 1000ppm of available chlorine.
- The concentration of the solution depends upon whether the object being cleaned is noticeably dirty (indicated in the table by "Product condition").

Table 9.3-1

Handling and storage safety precautions when using this cleaning agent:		
Advice on Safe Handling	Hygiene Measures	Conditions for Safe Storage
<p>Avoid contact with skin and eyes.</p> <p>Do not breathe dust, fumes, gas, mist, vapours, spray.</p> <p>Use only with adequate ventilation.</p> <p>Wash hands thoroughly after handling.</p> <p>Mixing this product with acid or ammonia releases chlorine gas.</p>	<p>Handle in accordance with good industrial hygiene and safety practice.</p> <p>Remove and wash contaminated clothing before re-use.</p> <p>Wash face, hands, and any exposed skin thoroughly after handling.</p>	<p>Keep out of reach of children.</p> <p>Keep container tightly closed.</p> <p>Store in suitable labelled containers.</p> <p>Storage temperature: 0-25°C (32-77°F).</p>
Individual Protective Measures	Dissolve	
Hand protection: Gloves	Dissolve in cold water – With no agitation, 1 tablet will take approximately 10 minutes to fully dissolve in the water used.	
<p>The information above has been extracted from the Actichlor™ MSDS (Manufacturers Safety Data Sheet). For a full review of the data please follow the link below:</p> <p><a href="http://www.nhsggc.org.uk/media/236215/msds-actichlor-plus.pdf">http://www.nhsggc.org.uk/media/236215/msds-actichlor-plus.pdf</a></p>		

Table 9.3-2



## 9.0 Servicing



No service is to be carried out on the Asiento chair while transferring a person to reduce the risk of injury.

Service must be completed by a Smirthwaite authorised service engineer.

Do not attempt to service the product yourself, or warranty is void.

To ensure the safety and continued good function of your chair, routine service must be performed. The Asiento chair should be serviced every 12 months to ensure the product required standard is maintained. Servicing must only be undertaken by a Smirthwaite Ltd. service engineer, or by a Smirthwaite Ltd. trained representative. The service history of the product should be documented each service in the Service Log at the back of this User Manual.

### 9.1 Nominal Service

Your product has a nominal service life of 7 years, during which full post-sales support will be available regarding spares and servicing.

Product service life has been determined based upon the design complexity of product, and the anticipated exposure to normal use.

Good practice dictates all Smirthwaite Ltd. products have been designed and manufactured to high levels of safety and quality and will meet requirements of normal use when maintained in line with our servicing recommendations.



If the product has been out of use for an extended period (6 months or more) it should always be serviced prior to being reissued. If the product has been subjected to 'heavy' or 'constant' use, the service should be reduced to half the recommended period.

Constant and/or heavy use is considered to be:

- Daily use above 7 hours' duration.
- Weekly use above 5 days' duration.
- Monthly use above 10 months per year.
- Use by a client who is at 90% to 100% of the maximum weight limit of the product. The maximum weight limit must NEVER be exceeded.
- Use by a client who is extremely active, either voluntarily or involuntarily.

### 9.2 Extending Nominal Service Life

At Smirthwaite Ltd. we are proud to produce products that have a reputation for quality and durability. We believe our products have the potential to provide benefits to our clients beyond the nominal service life documented above.

We will continue to provide full support beyond the nominal service life provided the following conditions are met:

1. A full-service schedule has been maintained.
2. A full service and inspection are undertaken at the end of the nominal service life period.
3. The product is subsequently serviced annually (or biannually if under 'heavy/constant' use conditions).
4. Smirthwaite Ltd. reserve the right to limit support where parts/components are no longer available.

### 9.3 User Serviceable Parts

Please contact Smirthwaite Ltd. or your local dealer for information to assist service requirements on the Asiento – e.g. to ascertain the necessary information for replacement parts and components. Contact details are shown on the last page of this manual.

Contact your local authorised Smirthwaite Ltd. dealer if you:

- Need more information.
- Have any questions about the use or service of your product.
- Notice any change in the performance.
- Want to report an unexpected occurrence.
- Want to arrange a service.
- Need to ascertain necessary information for replacement parts and components.

Contact details of your local Smirthwaite Ltd. dealer are shown on the last page of this manual.

### 9.4 Documentation/ Records

It is the responsibility of the current equipment owner to ensure the User Manual (As well as any further manuals for accessories fitted to the equipment) are handed over to the new owner at the time of exchange/sale.

It is the responsibility of the current equipment owner to ensure the service and inspection record form is kept up to date.

## 10.0 Troubleshooting

Should a problem arise with the use of the Asiento chair, review the table below. Find the fault and complete the recommended solution.

If the fault is not found and/or the solution does not correct the problem, contact your local Smirthwaite authorised dealer immediately – contact details are provided on the last page of this manual.

Table 10-1

Fault	Action
Castors do not operate.	Ensure the brake has been fully disengaged, Check the castors are free running Check the castors are touching the ground.
Movement is compromised by excessive force required to move the chair	Check the castors are not fouled with debris that would restrict its movement (clean out, test, and return to service).
Adjustment features loose/sliding (arm rests, footrests, backrest, headrest, seat, shoulder protractors, laterals, and removable tray	Ensure that the star handles are fully tightened in your preferred location. If the star handles are loose this allows the adjustments to move and adjust into unwanted locations. These features must always be set in position prior to use for the safety of the user.
Chair does not raise and lower or tilt in space as intended	Inspect the battery condition of the chair, ensure there is enough battery power to complete the action required, if this is not the issue, inspect the condition of the handset to ensure there is no damage along the length of the cord, following this the condition of the control box and actuators. If damaged, ensure to report this issue to your local authorised dealer. If the fault cannot be determined, then do not use the chair, and report a fault to your local authorised dealer.

## 11.0 Disposal

When the chair has completed its life cycle and can no longer perform to its intended use safely the chair must be decommissioned by an approved service engineer. The following specifies the importance of correct disposal procedure including local laws and being environmentally friendly.

Please observe the local laws on recycling and respect the current laws for disposal within the community the device is being used within. If there is any uncertainty of the below guidelines, contact your local authorities to determine the proper method of disposal of potentially biohazardous parts and accessories.

The relevant components utilised in the manufacture of the device that can be recycled at the end of the device life are:

Table 11-1

Fully recyclables:	Consideration when Recycling:
Metal frame (Frame, Base)	Headrest Padding
Castors	Shoulder Protractors Padding
Initial packaging of the device (cardboard)	Swing Away Laterals Padding
Metallic fixing – screws etc.	Adduction Pads
Leg Rests	Adduction Pads
Arm Rests	Hip Guides Padding
Quick Release Tray	
Metal Accessories	



The product may be contaminated and must be disinfected before recycling or disposal. See section on 'Cleaning' for details of how to do this.

## 12.0 Warranty

It is impossible for all the risks to be eliminated from use of this product, but to reduce risk and improve safety and proper use, the user should always read and understand the user manual before use. Product failure may occur due to lack of maintenance and care, misuse, unauthorised and improper servicing or alterations, improper storage, and environmental use, or through normal use wear and tear. These factors are all beyond the control from the manufacturer. These risks are taken on by the users.

The chair comes with a 2-year warranty covering all manufacture defects. Refer to your terms and conditions for more detailed information. The warranty is valid if the product has maintained its intended use and the user manual instructions have been followed. The warranty will not extend to the use of the product when used contrary to the user manual. This guarantee does not affect or in any way limit your statutory rights.

1. The liability of the manufacturer under the terms of this guarantee shall be limited to the replacement of the defective part(s) to the sales distributor, dealer, agent, person, or entity which purchased the equipment from the manufacturer. In no event shall the manufacturer incur liability for any consequential or unforeseeable losses.
2. This equipment guarantee shall be void if the equipment is not serviced by an authorised service engineer, in accordance with the manufacturer's recommendations, or if any unauthorised persons carry out work on the equipment.
3. This guarantee does not apply to failure attributable to normal wear and tear, damage by natural forces, user neglect or misuse or deliberate destruction.
4. Do not attempt to service the product yourself, or the warranty is void.

### 13.0 Service Record History

Complete this record after each service, repair inspection and/or maintenance.

\* Photocopy additional pages as required \*

#### 13.1.1 Product Information

Model	
Size	
Date of Manufacture	
Serial Number	

#### 13.1.2 Service & inspection record for

Date	Procedure	Service Personnel

Date	Procedure	Service Personnel
------	-----------	-------------------

--	--	--

--	--	--

--	--	--

--	--	--

--	--	--

Date	Procedure	Service Personnel
------	-----------	-------------------

--	--	--

--	--	--

--	--	--

--	--	--

--	--	--



**Dealer/service contact details:**

**Manufacturer contact details:**

Smirthwaite Ltd,  
16 Wentworth Road  
Heathfield  
Newton Abbot  
Devon  
TQ12 6TL  
Telephone Number: 01626 835552

## Disclaimer

While every effort has been made to ensure the accuracy of information contained in this user manual, no liability can be accepted by Smirthwaite Ltd for any errors or omissions. Smirthwaite Ltd operates a policy of continuous improvement. Specifications and other data are subject to change without notice.

**[www.smirthwaite.co.uk](http://www.smirthwaite.co.uk)**

